



**Owners Manual**  
**MAX-11/15 Upper Receiver**  
Patent Pending



LAGE Manufacturing, L.L.C. 916 E. Baseline Rd. STE #113 Mesa AZ 85204 CM1115-300B

**NFA Warning**

This upper receiver is designed to be used with the SWD M-11/9 submachine gun. NFA (National Firearms Act, Title 26, United States Code) rules apply to its use and possession.

It is the owner's/user's responsibility to comply with all local, State and Federal laws and regulations in the use of this product.

## WARNING:

**READ THIS MANUAL COMPLETELY BEFORE ASSEMBLING OR OPERATING THIS UPPER RECEIVER, TO PREVENT DAMAGE TO YOUR GUN, YOURSELF OR OTHERS.**

### Description/Features

#### Features:

- 1) Scope/Optics rail 12-3/4"
- 2) Charging Handle (non-reciprocating)
- 3) Shell Deflector
- 4) Ambidextrous Mag' Release
- 5) Rear Gas Seal
- 6) Bolt Carrier Group
- 7) 10-1/2 inch barrel (threaded 1/2-28)
- 8) Adjustable Gas Block
- 9) Handguard
- 10) Crush Washer
- 11) Flash Suppressor

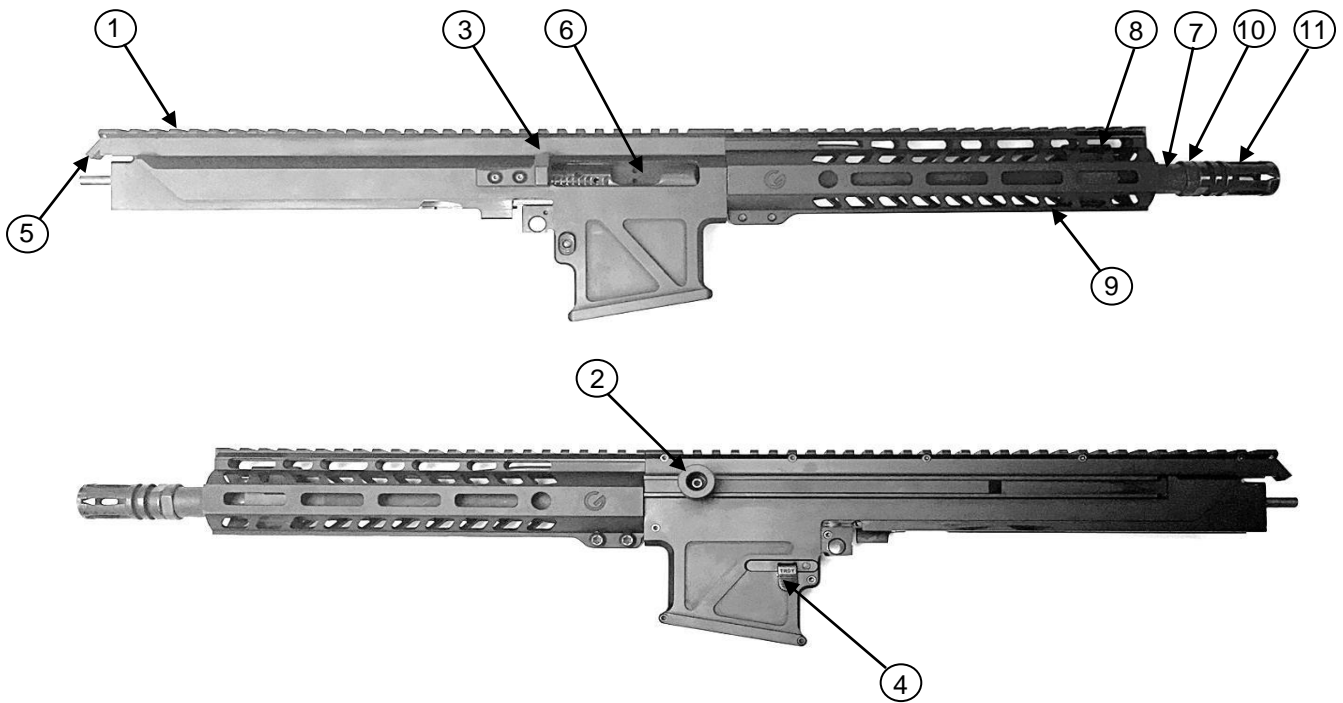

#### Upper Receiver

Length: 25-1/4"  
Width: 3"  
Height: 4-1/2"

#### Overall Length When Installed on Firearm

with 8-1/2" Folding Stock Extended: 33-3/4"  
with 8-1/2" Folding Stock Folded: 26"  
with AR Stock Collapsed: 33-1/8"

## Weight:

Upper Receiver with Internal Recoil Mechanism installed: 5 lbs, 2.8 oz.

Complete gun with Internal Recoil Mechanism and 8-1/2" Folding Stock installed  
Unloaded: 7 lbs, 8.4 oz.  
Loaded (30 Round Magazine): 8 lbs, 5.3 oz.

Upper Receiver with AR Recoil Mechanism installed: 4 lbs, 14.2 oz.

Complete gun with AR Recoil Mechanism and AR Buttstock Assembly installed  
Unloaded: 7 lbs, 12.1 oz.  
Loaded (30 Round Magazine): 8 lbs, 13.8 oz.

The MAX-11/15 is a rifle caliber upper receiver for the M-11/9 Sub Machinegun. It is chambered in 5.56 x 45mm but it is also compatible with .223 Remington ammunition.

The MAX-11/15 is designed to use standard AR-15 magazines.

Rate of fire is between 650 and 700 RPM, depending on ammunition used and the gas setting of the adjustable gas block.

The upper features a side charging, non-reciprocating, spring return charging handle on the left side.

A plastic shell deflector is fitted to provide comfortable shooting when operating left handed. Being plastic, it also minimizes deformation of the ejected brass.

Full length Picatinny rail on the top is the same height as an AR-15 flat top upper so standard AR foregrips with a rail on top are compatible.

Barrel mounting is AR compatible so different AR handguard mounts can be used, including the original AR delta ring and barrel nut.

An ambidextrous magazine release is provided to allow easy magazine changes with your left hand.

The upper receiver does not include removeable sights, scope or optics.

Barrel length is 10-1/2" and is 1:7 twist.

The MAX-11/15 Upper Receiver is available with two different recoil systems, the Internal Recoil Mechanism or the AR Recoil Mechanism.

### **Internal Recoil Mechanism (IRM)**

The Internal Recoil Mechanism (IRM) consists of a Bolt Assembly, Recoil Spring, Recoil Plate and Buffer and does not require drilling the rear sight plate. If a Lage Manufacturing Internal Gas Block is installed in the lower receiver, it must be removed.

NOTE: The IRM version does not include an AR Stock Assembly, as it does not require it for operation. The IRM can use any stock that will attach to the M-11/9 Lower Receiver. If you desire the AR Stock Assembly, it can be purchase seperately.□

### **AR Recoil Mechanism (ARRM)**

The AR Recoil Mechanism and stock assembly requires the lower receiver to be modified by drilling a 5/16" (.312") hole through the rear sight plate. The stock adapter is provided with an integral drill bushing to locate the hole and provide guidance for the provided drill bit.

The AR Recoil Mechanism includes a stock assembly that consists of a stock adapter, end plate, buffer tube, castle nut, carbine buffer, custom AR-15 recoil spring and Magpul MOE buttstock.

### **Upper Receiver**

Made from 7075 aluminum and finished in PTFE Impregnated Type III Black Anodize.

### **Charging Handle**

The charging handle is a side charging, non-reciprocating, spring return design. It is compatible with all standard AR configuration Bolt Carrier Groups.

### **Shell Deflector**

Deflects shells away from the shooter, especially helpful for left handed shooters. Being plastic, it also minimizes deformation of the ejected brass.

### **Magazine Release**

The magazine release is a Troy Industries ambidextrous release. This makes magazine release with the left hand easier by just grabbing the magazine and using your thumb to swipe the magazine release lever on the left side of the gun. A standard magazine release button is located on the right side.

### **Rear gas seal**

The upper is fitted with a rubber gas seal at the top rear to prevent smoke and debris from being directed towards the shooter's face when firing with a sound suppressor.

### **Piston Compatible**

The upper is designed to be compatible with Adams Arms Piston kits, and possibly others. The upper receiver will accept the pressed in steel bushing.

### **Bolt Carrier Group**

The bolt head is manufactured from Carpenter 158 steel and is Magnetic Particle Inspected (MPI). The finish is black nitride.

### **Barrel**

Barrel is 10-1/2" long, chrome lined with a phosphate finish and chambered for 5.56 x 45mm ammunition. It is also compatible with .223 Remington ammunition. Rifling twist is 1:7.

### **Adjustable Gas Block**

An Odin Works adjustable gas block is installed on the barrel. This allows the gas system to be tuned to your specific ammunition to allow softer recoil and a lower rate of fire.

### **Handguard**

Handguard is aluminum and features M-LOK mounting points and a steel barrel nut for durability. With extensive use, the handguard can get uncomfortably hot. We recommend you install M-LOK™, TYPE 2 Rail Covers to insulate your hand from the heat transmitted from the hand guard.

### **Flash Hider**

The flash hider is an M16-A1 style with slots around its full diameter. It is installed with a jam nut to protect the barrel shoulder and allow a non-marred surface to attach a sound suppressor. The barrel muzzle is threaded 1/2-28.

## Installation

### WARNING:

You **MUST** inspect your safety prior to using this upper receiver.

When using the MAX-11/15 upper receiver with an M-11/9 SMG that has an extended safety or aftermarket safety installed, make sure the safety positively engages in the "FIRE" and "SAFE" positions. If the safety wobbles or is easily disengaged, it may move to the "SAFE" position while firing, causing the gun to jam with bolt partially opened.

An extra strength safety spring is included for you to install. One end is larger than the other and must be twisted into the hole in the safety slide.

### WARNING:

Always remember that this system works with an open bolt and fixed firing pin. Pushing the bolt into a bullet or pushing the bullet into the bolt can cause the bullet to fire.

The MAX-11/15 Upper Receiver is available with two different recoil systems, the Internal Recoil Mechanism and the AR Recoil Mechanism.

#### Internal Recoil Mechanism

The Internal Recoil Mechanism (IRM) consists of a Bolt Assembly, Recoil Spring, Latching Recoil Plate and Buffer. The Buffer is preloaded onto the Recoil Plate. An Installation Guide Rod is used to install the IRM.

#### Components

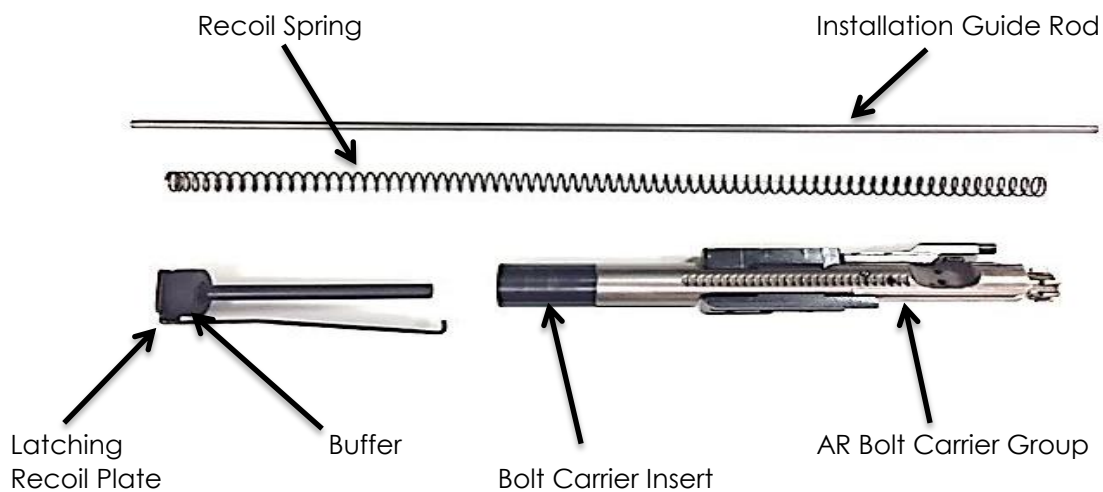

### Assembled



### Assembled, Recoil Spring Compressed and Latched

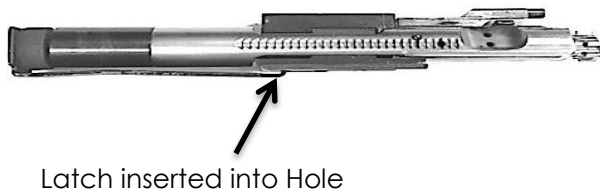

To install the Internal Recoil Mechanism:

- 1) Place the bolt end of the bolt assembly against a bench or your waist.
- 2) Place the 3/16" (.187") diameter guide rod into the hole through the center of the back of the bolt assembly.
- 3) Slide the recoil spring over the rod and into the back of the bolt assembly.
- 4) Slide the recoil plate tube onto the rod with the square end opposite of the bolt assembly.

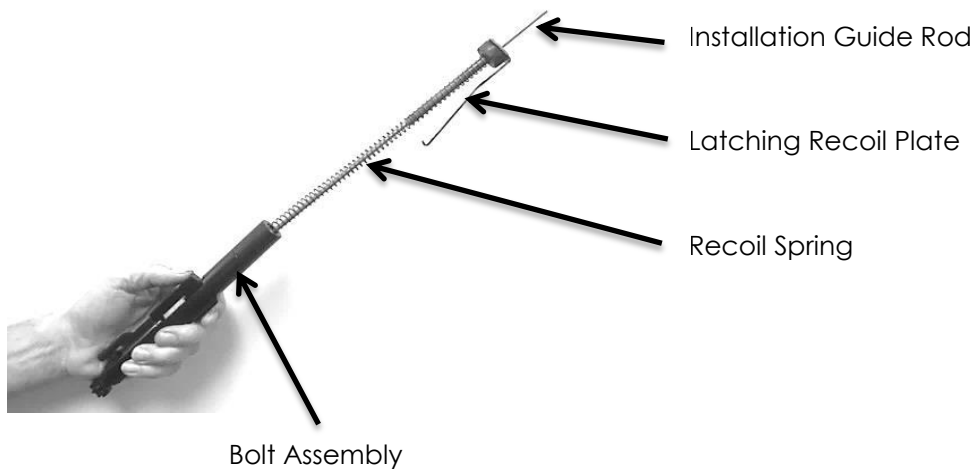

- 8) Place the bolt against a bench or your hip and align the latch on the recoil plate with the bottom of the bolt assembly and slide the recoil plate down the rod, compressing the spring.



- 9) Align the latch on the recoil plate with the bottom of the bolt assembly and slide the recoil plate down the rod, compressing the spring.

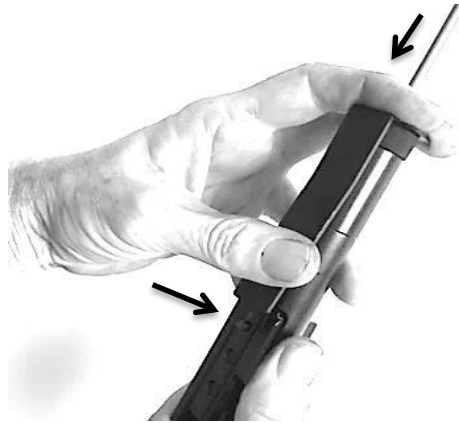

- 10) Align the hook on the latch with the corresponding hole on the bottom of the sear plate and press it into place. This will hold the recoil plate in place with the spring compressed.





11) Remove the guide rod.



12) Extend the bolt head on the bolt assembly and insert it into the rear of the upper receiver. When fully seated, the rear rectangular plate of the recoil plate will be flush with the back of the upper receiver and the rubber buffer will be inside.

13) Install the upper receiver to the lower receiver per the instructions shown on page 12.

14) The bolt will remain in the rearward position and the trigger will not release the bolt. Fully cock the bolt back to release to the bolt.

15) Perform function test shown on page 13.

#### **Removing the IRM:**

If you remove the upper receiver from the lower receiver, the recoil spring will pop free once they are separated. To make disassembly easier and prevent damage to the spring, the recoil spring can be compressed and latched in place before removing the upper from the lower receiver by doing the following:

1) Make sure magazine is empty and removed and the chamber is clear of any ammunition.

2) Pull the charging handle back until the sear catches the bolt in the rear position.

3) Insert an un-loaded M-11/9 magazine into the hand grip magazine housing of the M-11/9 Lower Receiver.

- 4) If the magazine does not latch in, apply light upward pressure while pulling the charging handle further rearward. The magazine follower should push up on the latch and engage the hook into the hole in the bottom of the bolt assembly. The bolt will retract an additional 1/8" to 1/4" and lock in place. To test to see if the hook is engaged, release the charging handle and pull the trigger. The bolt should not release. If it does, repeat the latching process until it locks the bolt rearward.



- 5) Remove the retaining pin and remove the upper from the lower receiver.
- 6) Grab the recoil plate and pull the bolt assembly from the rear of the upper receiver.

To release the recoil spring from the IRM:

- 1) Insert the guide rod through the rear of the recoil plate, making sure the rod seats inside the bolt assembly.
- 2) Place the bolt end of the bolt assembly against a bench or your waist.
- 3) Maintain pressure on the guide rod and compress the rear of the recoil plate towards the front of the bolt assembly. The hook on the latch should release. If it does not, pull the hook out of the hole with your finger.
- 4) Maintain pressure on the guide rod and slowly slide the recoil plate away from the bolt assembly until the spring tension is released.
- 5) Slide the recoil plate off of the guide rod, then remove the spring and guide rod.

For long term storage, it is recommended that the IRM be stored with the recoil spring released in its extended state.

## AR Recoil Mechanism:

The AR Recoil System consists of a standard AR Bolt Carrier Group with the addition of an Operating Rod, Bolt Carrier Insert, Sear Plate and Sear Plate Clamp. An AR Stock Adapter, End Plate, Buffer Tube, Buffer, Buffer Spring and Stock are also provided.

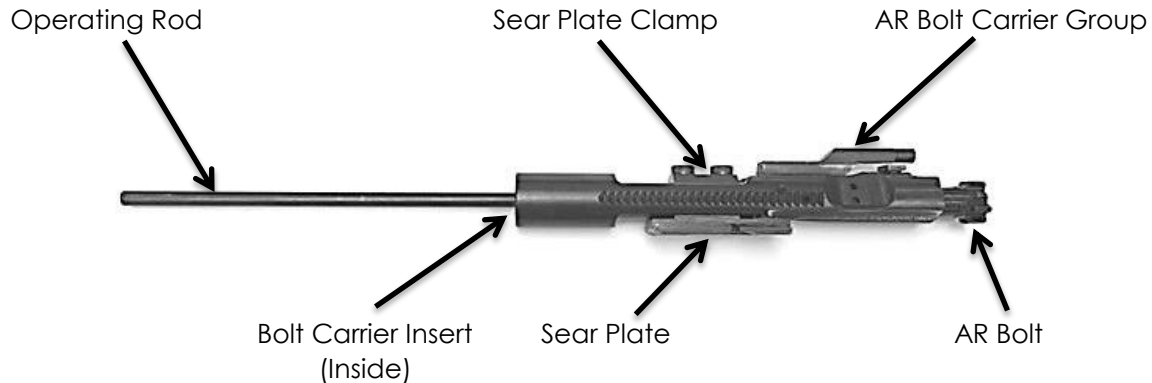

This recoil mechanism requires the lower receiver to be modified by drilling a 5/16" (.312") hole through the rear sight plate. The stock adapter is provided with an integral drill bushing to locate the hole and provide guidance for the drill bit.

If you do not feel comfortable doing this process, please use a qualified gunsmith to drill the hole. It is not necessary to remove the fire control parts or strip the lower receiver to do this modification, but you may prefer to do so.

To install the AR Recoil Mechanism:

- 1) Remove existing stock and stock latch mechanism.
- 2) Remove AR Stock adapter from stock assembly by unscrewing counter clockwise. Be careful unscrewing the stock adapter since the recoil spring is compressed and will spring out when the stock adapter is removed.
- 3) Assemble stock adapter to rear of lower receiver using provided threaded stock block, screw and bushing. The stock block drops in from the inside of the lower receiver and the screw and bushing assembles from the bottom. Thread screw into threaded stock block and tighten to 40 in-lb.
- 4) Place the lower receiver in a padded vise to protect the finish of the lower receiver. Securely tighten the vise to insure the receiver will not move while drilling the hole. Make sure lower receiver and stock adapter are secured by the vise jaws.



- 5) An electric hand drill is sufficient for drilling through the rear of the lower receiver.
- 6) Use cutting oil on the 5/16" (.312") drill bit and low RPM's to drill the hole.
- 7) Drill the hole a little bit, then remove the drill bit, clear any chips and add more cutting oil to the tip and drill bushing. Repeat as necessary until the hole is drilled through.



- 8) Remove the stock adapter, threaded stock block, screw and bushing. Inspect the hole for burrs and carefully dress any sharp edges with a fine round jeweler's file.
- 9) If preferred, you can touch up the exposed bare steel in the hole with a cold blue product or touch up pen.
- 10) Using compressed air or brake cleaner, blow out any debris that may have entered the lower receiver.
- 11) If you removed the fire control parts or stripped the lower receiver, re-install the parts.
- 12) With Recoil Spring and Buffer installed in Buffer Tube of Stock Assembly, re-assemble Stock Adapter to the Stock Assembly. Align Buffer with inside of AR Stock Adapter and push towards Stock, compressing Recoil Spring. Rotate AR Stock Adapter clockwise and thread onto Buffer Tube until it stops.
- 13) Unthread Buffer Tube until End Plate aligns with recess in Stock Adapter.
- 14) Thread Castle Nut up to End Plate and tighten.

### **Adjustable Stock Latch**

The Adjustable Stock Latch is designed to minimize up and down play between the upper and lower receiver. Two #10-32 nylon set screws can be adjusted to provide a snug fit.

To install,

- 1) Rotate the selector to the "AUTO" setting and insert the Stock Assembly into the rear of the lower receiver and place the Adjustable Stock Latch into the lower receiver from the top with the flat nylon tips of the set screws facing up. Do not install the bushing or screw from the bottom yet.

- 2) Install the upper per the above procedure and check for looseness between the upper and lower receiver.
- 3) To adjust, use a 5/64" (.078") Allen Wrench and turn the set screws clockwise one turn at a time and test fit the upper. If the upper is still loose, turn each screw another full turn and recheck.
- 4) Repeat as necessary until you find that the upper cannot be lowered into the upper without resistance. Back the screws off an equal amount until it slides in without resistance and has minimal play.
- 5) Using a 5/32" (.156") hex driver, install the screw and bushing into the bottom of the receiver, thread it into the stock latch and tighten to 40 in-lb.

You may have to re-adjust the screws when attaching a different upper.

Since the Adjustable Stock Latch locks in place, it is not compatible with Collapsible Stocks.

## Installation- Assembly of the upper receiver to the lower receiver.

- 1) Insure firearm is unloaded. Point in a safe direction. Remove magazine and pull bolt to the rear to insure chamber is empty.

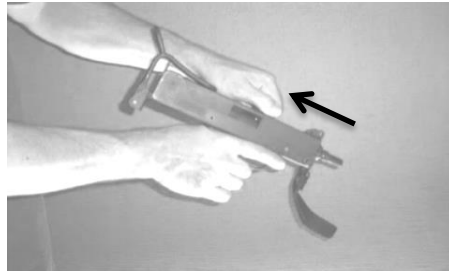

- 2) While holding cocking knob, pull trigger and ease bolt forward

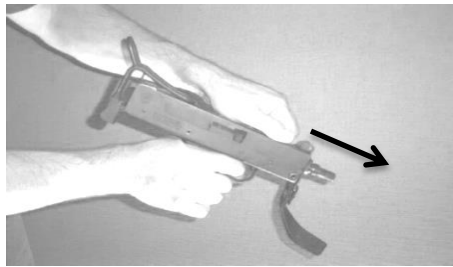

- 3) Remove retaining pin and detach upper receiver from lower receiver.  
NOTE: If the IRM version is to be installed make sure a Lage Manufacturing Internal Gas Block is not installed in the lower receiver.

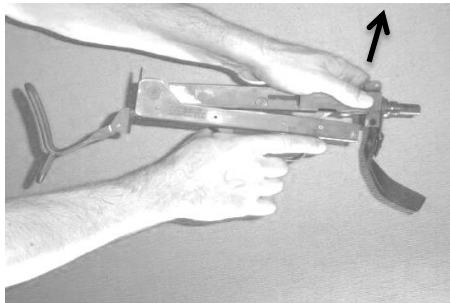

- 4) Rotate rubber gas block at rear top of upper receiver so that it is near horizontal.

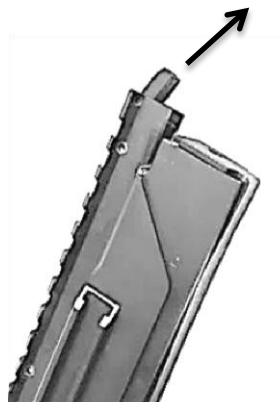

- 5) Slide the upper receiver into the back of the lower receiver. For the ARRM version, make sure the operating rod attached to the bolt assembly is inserted through the hole in the rear of the lower receiver.



- 6) The rubber gas block will rotate into a vertical position when it hits the rear sight. This will keep it in position.



- 7) Align the retaining pin holes of the upper and lower receiver and insert retaining pin.
- 8) Retract the charging handle on the left hand side of the upper receiver a couple of times to insure the bolt is not binding.

### Function Test

With the firearm **UNLOADED**, perform a function test of the fire control parts.

- 1) Rotate selector to the "SMG" or "AUTO" position.
- 2) Retract the charging handle until the bolt is held rearward with the sear.
- 3) Slide the safety rearward to the "SAFE" position.
- 4) Pull the trigger and insure the bolt is not released.
- 5) Slide the safety forward to the "FIRE" position.
- 6) Pull the trigger and verify the bolt is released.

- 7) Retract the charging handle again until the bolt is held rearward with the sear.
- 8) Rotate selector to the "SEMI" position.
  
- 9) Pull the trigger and HOLD IT TO THE REAR. When the bolt slides forward, CONTINUE HOLDING THE TRIGGER TO THE REAR and retract the charging handle. WITH THE TRIGGER STILL BEING HELD BACK, the bolt should stay in the rearward position being held by the sear.

## **Loading and Firing**

Use quality ammunition of recent manufacture. For best performance, use 5.56x45mm M193 ammunition,

DO NOT USE Laquer coated steel case ammunition. If you are unsure of the coating on your ammunition, do not use it. Through testing, we have found that this ammunition when fired can become stuck in the chamber. This can cause excessive wear on the extractor and cause it to break. Use of laquer coated steel case ammunition will void the Warranty.

When loading polymer magazines, make sure you do not overload the magazines. Many polymer magazines will allow an extra round to be loaded. This requires extra stripping force and may cause the first round of the magazine to not completely feed or fire once chambered.

The MAX-11/15 fires from an Open Bolt. When you cock the bolt back, it will stay back until the trigger is pulled. Unlike a standard AR-15 rifle, It will not chamber a round until it is being fired.

- 1) Rotate selector to the "SEMI" or "AUTO" position.
- 2) Cock the bolt back before inserting a loaded magazine.
- 3) Keep gun pointed in a safe direction and insert a loaded magazine.
- 4) Slide the safety forward to the "FIRE" position.
- 5) Aim at target and fire.
- 6) When finished firing, cock the bolt back and slide the safety to the rearward "SAFE" position.



## Adjustable gas block

The MAX-11/15 upper receiver features an Odin Works Adjustable Gas Block.

It is pre-set at the factory at **11 clicks** from fully closed. With this setting, the MAX-11/15 should run most ammunition without a problem, but you should adjust the gas system to its lowest setting for the ammo you are using. This will provide the lowest rate of fire, make the gun more controllable and reduce wear and tear on your lower receiver. If you change the ammunition that you have the gas block adjusted to, you may have to readjust the gas setting.

To adjust the gas system:

- 1) Slide the safety to the "FIRE" setting, rotate the selector to "Semi" and cock the bolt back.
- 2) Insert a magazine loaded with three rounds of ammunition. Fire one round and verify the bolt locks back after the first shot.

### **If it fires one round:**

- 1) Remove the magazine and pull the charging handle back to insure there is not a round in the chamber or receiver.
- 2) Use the provided 7/64" (.109") Allen Wrench to adjust the gas block by rotating the adjusting screw one click clockwise (when viewed from the muzzle end). When adjusting the screw, make sure the muzzle is pointed in a safe direction.
- 3) Reload three rounds in the magazine and shoot the gun again, verifying it shoots only one round. Repeat the process above if it does.
- 4) When you have adjusted it so that it will fire more than one shot or the bolt short strokes and does not pick up another round, rotate the adjusting screw two clicks counter clockwise.
- 5) When finished adjusting, load 30 rounds in a magazine and fire all 30 rounds in sem-automatic mode to make sure that it only fires one shot, as intended.
- 6) Continue to adjust the gas block if it does not.

### **If it fires more than one round or short strokes the bolt and has a feed jam:**

- 1) Remove the magazine and pull the charging handle back to insure there is not a round in the chamber or receiver.
- 2) Use the provided 7/64" (.109") Allen Wrench to adjust the gas block by rotating the adjusting screw one click counter clockwise (when viewed from the muzzle end). When adjusting the screw, make sure the muzzle is pointed in a safe direction.
- 3) Reload three rounds in the magazine and shoot the gun again, verifying it shoots only one round. Repeat the process above, if it does not. When you have adjusted it so that it will only fire one shot, rotate the adjusting screw one more click counter clockwise.

- 4) When finished adjusting, load 30 rounds in a magazine and fire all 30 rounds in semi-automatic mode to make sure that it only fires one shot, as intended.
- 5) Continue to adjust the gas block if it does not.

For reference, here are some starting points for different ammo with the Internal Recoil Mechanism (IRM) and the AR Recoil Mechanism (ARRM):

IMI is mil-spec ammo and runs hotter than Wolf Classic. Wolf Classic is the weakest ammo we tested. Rate Of fire (ROF) is approximate. Clicks are measured from the fully screwed in or closed position.

	IMI		Wolf Classic	
	Clicks	ROF	Clicks	ROF
<b>IRM</b>	<b>9</b>	<b>690</b>	<b>11-17</b>	<b>653</b>
<b>ARRM</b>	<b>9</b>	<b>664</b>	<b>10</b>	<b>682</b>

With extensive use, the gas adjusting screw may become carbon fouled, stuck or stripped. Odin Works sells an inexpensive rebuild kit to solve this problem.

## WARNING:

**If the bolt is ever jammed shut, it is safest to assume that there is a live round and not an empty shell in the chamber. Furthermore, do not insert a cleaning rod or other rod down the barrel and attempt to hammer out the round or empty shell. With a live round in the chamber, hammering it out will cause the fixed firing pin to impact the primer causing the round to discharge along with what ever rod or device you inserted.**

**If the bolt ever jams shut or partially extracts with a stuck shell, wait a couple of minutes to insure the round is not a "hang fire". Then, point the gun in a safe direction and carefully remove the upper from the lower receiver by removing the retaining pin and pulling the upper forward and up from the lower receiver.**

If the gun jams with the bolt partially rearward and the safety has slid to the forward "Safe" position, point the firearm in a safe direction and use a punch to drive out the retaining pin so the upper can be removed from the lower receiver. Once the upper is removed, the bolt will freely move and eject the round.

Do not try to "Mortar" the bolt back to unjam it. The bolt is wedged between the sear and internal safety slide underneath it. This creates a wedge which is only increased when the bolt is forced back. Do not slam the muzzle down onto a surface or hammer it to create inertia to move the bolt forward. If there is a live round in the chamber, you risk igniting the round.

This type of jam is caused by a weak safety spring or use of an aftermarket or extended safety. Replace safety spring with the one provided with the upper receiver.

## Cleaning and Maintenance

Recommended cleaning interval is every 500 rounds.

- 1) Remove the Bolt Carrier Group and clean and lubricate it.
- 2) Clean the inside of the upper receiver and Charging Handle slot. You can clean the charging handle slot by using solvent and compressed air or an aerosol cleaner (automotive brake cleaner works well). Add a couple of drops of gun oil into the Charging Handle Slot and Spring inside the upper receiver.
- 3) Clean and lubricate the barrel and chamber area.
- 4) Clean and lightly lubricate the recoil spring.

We recommend replacing the AR Bolt Assembly (bolt head, gas rings, cam pin and extractor, extractor spring, extractor o-ring and extractor pin) every 5,000 rounds.

The upper receiver is a two piece design with left and right sides that are secured with screws. The halves do not need to be disassembled for routine maintenance.

The Charging Handle Assembly is secured within the left half of the upper receiver and does not need to be removed for cleaning.

The Barrel assembles into the upper receiver in the normal manner that an AR-15 barrel is installed except the barrel nut requires a 30 mm wrench to remove or install it.

### **Bolt Carrier Group (BCG) Disassembly**

To disassemble the BCG for cleaning or maintenance:

- 1) Place the BCG in a smooth faced vise, holding it by the sides of the Sear Plate .
- 2) Using a 3/16" (.187") Hex Driver, remove the two screws from the top of the Sear Plate Clamp.
- 3) The Bolt will come free from the Sear Plate. Leave the Sear Plate in the vise to make reassembly easier.
- 4) With the Bolt in your hand, slide the bolt carrier insert out from the rear.
- 5) The rest of the BCG parts remove and install the same as any AR-15 BCG parts.

To reassemble the BCG:

- 1) Insert the Bolt Carrier Insert into the rear of the BCG and align the screw holes top to bottom.
- 2) Place the BCG on top of the Sear Plate installed in the vise.
- 3) Place the Sear Plate Clamp on top of the BCG.
- 4) Apply Red Loctite to the threads of the two screws and insert them through the Sear Plate Clamp and Bolt Carrier Insert and into the Sear Plate underneath. Hand tighten the screws, but leave them loose enough so the Bolt Carrier Insert can slide.

- 5) With everything still in the vise, slide the BCG towards the Bolt carrier insert and hold it in place while tightening the screws to 40 ft-lb. When tightening the screws, make sure the Sear Plate remains parallel with the BCG. When finished, the rear of the bolt carrier must be flush with the Bolt Carrier Insert.

### **Bolt Cam Pin Wear in Upper Receiver**

With use, you may notice wear in the upper receiver from the Bolt Cam Pin. This is normal and is not attributable to use of either recoil mechanism (IRM or ARRM). This wear will not affect the function of the upper receiver and is common in AR-15 rifles.



## Warranty and Repair

### WARRANTY

*Note: Use of reloaded/remanufactured ammunition or laquer coated ammunition will void your warranty*

*The MAX-11/15 Upper Receiver has been manufactured in a manner to insure it is defect free and durable. LAGE Manufacturing, L.L.C. warrants to the original purchaser that this product is free from defects in materials and workmanship for the period of One Year from the original date of purchase. This warranty does not apply to damage due directly or indirectly, to misuse, abuse, negligence or accidental, repairs or alterations outside our facilities or to lack of maintenance. We shall in no event be liable for death, injuries to persons or property or for incidental, contingent, special or consequential damages arising from the use of this product. The above limitation of exclusion may be subject to state law and may not apply to you.*

*To utilize this warranty, the MAX-11/15 Upper Receiver must be returned to us packaged in a manner to preclude damage during transit and with shipping charges prepaid. Proof of purchase date and a written description of the complaint must be included. If upon inspection, the complaint is verified, we will either repair or replace the product at our election or we may elect to refund the purchase price if we cannot readily and quickly provide a replacement. We will return the repaired product at our expense, but if we determine that there is no defect, or that the defect was a result of causes not within the scope of this warranty, then you must bear the cost of returning the product.*

*This warranty gives you specific legal rights and you may have other rights, which vary from state to state.*









































