



## Owners Manual MAX-31 mk2 Upper Receiver



LAGE Manufacturing, L.L.C. 170 S. William Dillard Dr. #102 Gilbert, AZ 85233

CM11-410, Rev. B

**NFA Warning**

This upper receiver is designed to be used with the SWD M-11/9 submachine gun. NFA (National Firearms Act, Title 26, United States Code) rules apply to its use and possession.

It is the owners/users responsibility to comply with all local, State and Federal laws and regulations in the use of this product.

## Description/Features

The MAX-31 mk2 Upper Receiver is designed to provide additional capability to the SWD M-11/9 submachinegun. Utilizing a heavy bolt and longer bolt stroke, the rate of fire is reduced to around 770 rounds per minute. This allows easy controllability of fire and the ability to consistently fire single and two round bursts from the automatic setting.

The MAX-31 mk2 is designed to use Suomi M31 72 round drum and 50 round coffin magazines. This upper will not function with the 36 round stick mag's which are double feed.

The MAX-31 mk2 does not include removeable sights, scope or optics.

The MAX-31 mk2 attaches to the stock M-11/9 lower receiver without any modification to the lower receiver.

### Features:

- |  |   |
|--|---|
| 1) Scope/Optics rail 18-1/8"                                 | 6) Flash Suppressor   |
| 2) Cocking Handle (non-reciprocating)                        | 7) Mag catch  |
| 3) Lower Accessory Rail 5-1/4"                               | 8) Trigger guard filler<br>(contains mag' catch and<br>mag' catch spring) |
| 4) Side Accessory Rail Mounting Points                       |   |
| 5) 8-3/8 inch barrel length, removeable<br>(threaded 1/2-28) |   |

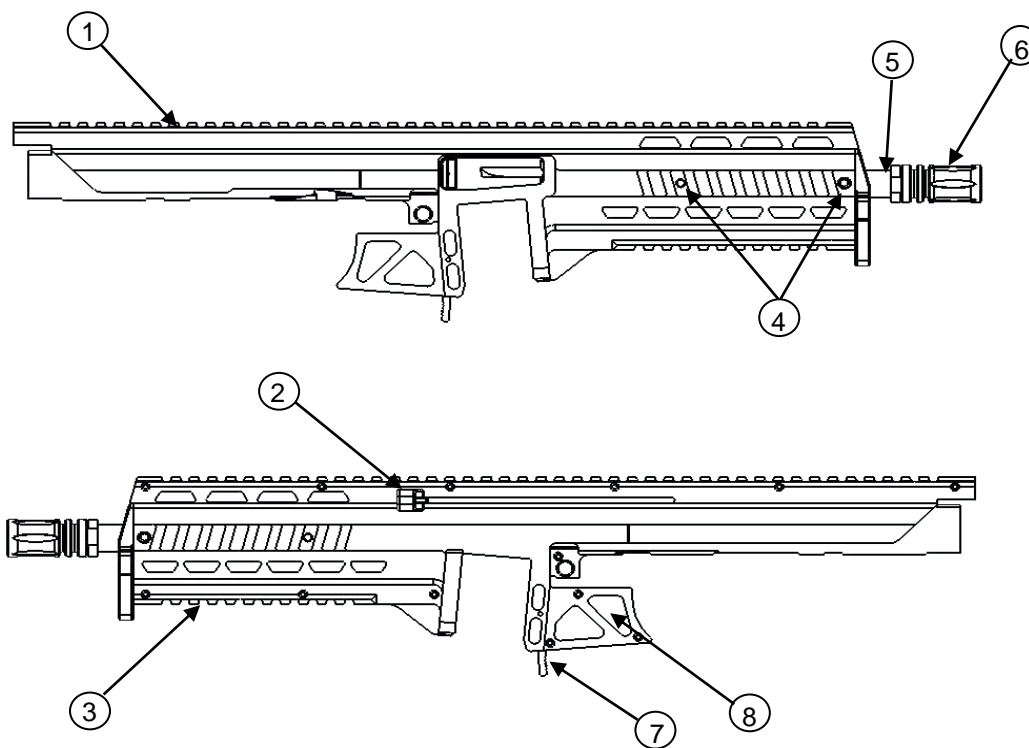

Length: 21"

Width: 2-1/4"

Height: 4-11/16"

Overall length with 7-1/2" fixed stock- 28-1/2"

Weight: 4 pounds

## Installation

- ① Insure firearm is unloaded. Point in a safe direction. Remove magazine and pull bolt to the rear to insure chamber is empty.

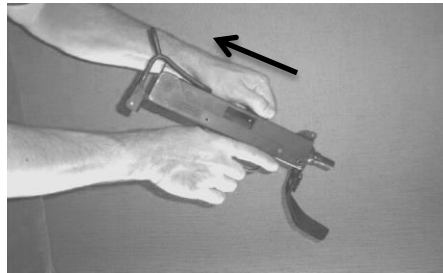

- ② While holding cocking knob, pull trigger and ease bolt forward into closed position.

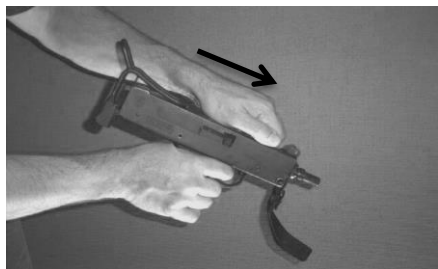

- ③ Remove retaining pin and detach upper receiver from lower receiver.



- ④ Make sure selector is set to "SMG". This drops the trip down and makes it easier to install the upper. Hold upper receiver with muzzle pointing down to prevent bolt assembly from sliding out. Pull and hold trigger back while installing the upper. Install upper by aligning the rear of the upper receiver with the rear of the lower receiver, keeping both receivers parallel. As you slide the upper into the lower pay careful attention to not push the front of the lower receiver into the trigger guard filler of the upper receiver, or you may scratch the finish on your lower receiver. If receiver will not install all of the way forward, wiggle receiver up and down until it moves forward.



- ⑤ Align retaining pin hole and install retaining pin.

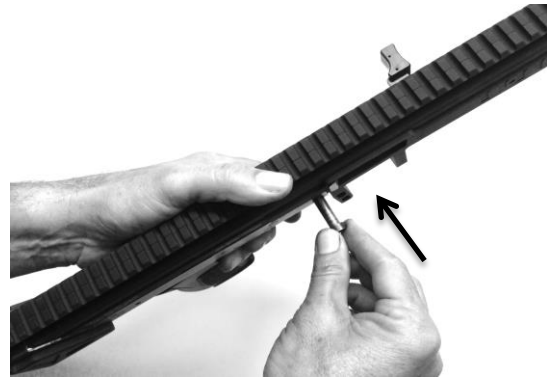

## Removal

- ① Point firearm in a safe direction and ensure it is unloaded and magazine is removed.
- ② Hold gun with muzzle pointing down and remove retaining pin.
- ③ Pull lower receiver back about an 1/8", then pull trigger and hold. While holding trigger back, pull lower receiver downward and back to remove.



## Operation

### Recommended ammunition:

Use only full power 9mm ammunition such as Winchester White Box 115 gr. Round Nose ammunition.

Using weak ammo will may in short uncontrolled bursts of 3 to 5 rounds.

If you are unsure of your ammunition, only load 10 rounds in the magazine and test to see if it continues to shoot after releasing the trigger.

Do not use steel cased ammo in the 50 round Suomi coffin magazines. The increased friction of the steel cases will cause feed jams. Steel cased ammo will work fine in the drum magazines.

Rate of fire is dependent upon ammunition being used. "Hotter" ammo will run faster and weaker ammo will run slower. Winchester White Box ammo will run at approximately 770 RPM.

## Load magazine:

Cock gun first before installing magazine.  
Insert loaded magazine into mag well.

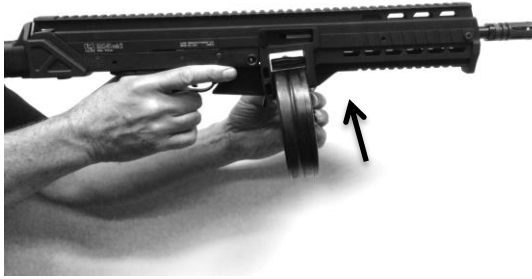

Due to variations in magazines, some magazines may be a snug fit but most will fit loosely. The magazine may have a lot of play after installation, but this will not affect functioning of the MAX-31 mk2.

Extra magazines can be purchased from:

Centerfire Systems  
102 Fieldview Dr.  
Versailles, KY 40383  
[www.centerfiresystems.com](http://www.centerfiresystems.com)  
1-800-950-1231

## Cocking

Pull cocking knob to rear and release. Bolt will remain open.  
Cocking knob has a spring return and will return forward after release.  
Cocking knob is non-reciprocating and will remain forward when firing.

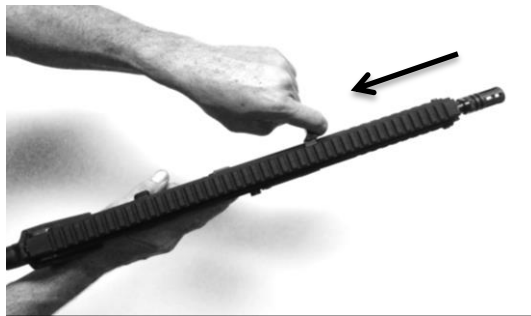

### Note:

Cocking assembly may slightly bind when first used. With use and lubrication, it will feel smoother.

If gun jams with the bolt forced closed, do not force the cocking knob or hit it with a hammer. Remove upper receiver from lower receiver. Use a screw driver to depress the rear of the extractor and release the case rim. Remove the bolt assembly, then use a cleaning rod or dowel from the muzzle end to tap the bullet out.

## Recommended source for magazines:

Centerfire Systems

Part Number #M31DRUM

Condition of magazines- magazines are of varying quality due to the fact that they are surplus military magazines. Steel surface may show pitting, wear marks or light scratches. Magazine is coated with grease. Make sure you clean the inside thoroughly before loading.

## Scope/Optics Rail

A full length rail for mounting a scope or other aiming device is located on the top of the upper receiver. The rail profile is compatible with most scope mounts, however, square shaped recoil lugs may not work. These are typically found on quick detach, throw lever mounts such as LaRue Tactical mounts. UTG quick detach mounts are compatible as well as others. When installing a mount, do not force it or you may damage the upper receiver accessory rail.

## Lower Accessory Rail

A rail for attaching a front hand grip, laser aiming device, tactical flashlight or other device is attached to the bottom of the front handgrip.

Please note, some hand grips are not manufactured to the correct dimensions to mount on a Mil-Std-1913 rail. Ensure the grip is correct before attaching.

Additionally, tactical flashlights designed for use with pistol accessory rails will fit on the accessory rail but will be a tighter fit.

If the item you are going to install needs to slide on from the front, you can remove the two screws that hold the front cover on, pull it forward and rotate it out of the way. You can then slide on your grip, laser, light, etc. and re-install the front cover. Make sure you use Loctite 242 to secure the threads.



## Side Accessory Rails (optional)

The MAX-31 mk2 can be fitted with left and right side accessory rails for mounting additional accessories. They are installed by using the threaded holes on the sides of the foregrip. Screw threads are #10-32. When installing the screws, use Loctite 242 on the threads and be careful not to overtighten the screws.



## Variable Buffer System, VBS-2 (optional)

To adjust the rate of fire, the MAX-31 mk2 is designed to use a variable buffer system. (VBS) The VBS consists of 2 buffer spacers that can be placed on the bolt assembly between the rear of the bolt and the rubber buffer.

The following rates of fire can be achieved:

Configuration:	Rate of Fire with Winchester 115 gr Ammo	Rate of Fire with Federal 115 gr Ammo
	Standard Bolt	770
One VBS Spacer installed	830	710
Two VBS Spacers installed	840	800

Different bullet weights, such as 124 gr. And 147 gr. , as well as lighter or stronger powered ammunition, will result in slower or faster rates of fire. The rates of fire above are approximate. The rate of fire of your ammunition may vary.

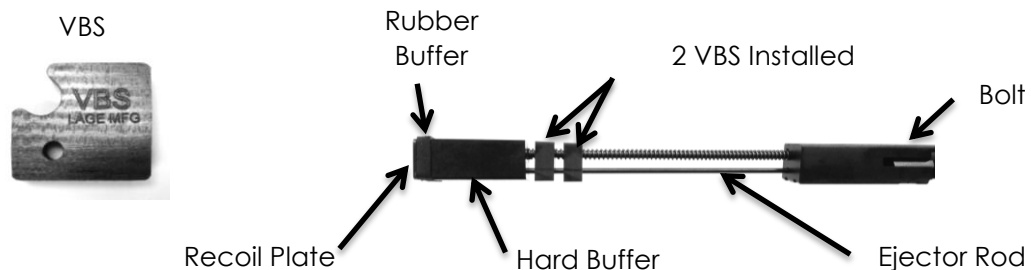

## Attachment of other muzzle devices

The barrel is threaded 1/2-28. The flash suppressor is torqued to 25 foot/pounds and secured with Loctite Threadlocker 242. A lockwasher is intentionally not used in order to ensure the mounting surface of the barrel remains square and burr free for optional use with a suppressor. If you choose to replace the flash suppressor with another type of muzzle device, insure it is designed for use with 9mm caliber bullets.

To prevent marring of the finish, apply masking tape to the flats on the barrel end and the flash suppressor. To remove the flash suppressor, attach a 3/4" open end wrench to the wrench flats on the barrel. Attach a second 3/4" open end wrench to the wrench flats on the flash suppressor. While holding the wrench attached to the barrel stationary, rotate the wrench attached to the flash suppressor counter-clockwise.





## Attachment of a Sound Suppressor

A sound suppressor may be attached to the MAX-31 mk2 by removing the flash suppressor. The threads on the MAX-31 mk2 barrel are 1/2-28. A thread adapter can be used to couple suppressors with other thread sizes or mounting systems. Most commonly, a 1/2-28 to 3/4-10 thread adapter is required to use the suppressor that mates to the stock SWD M-11/9. When using the suppressor with the thread adapter, regularly tighten the suppressor to the thread adapter. It will have a tendency to loosen during firing. This is typical of the 3/4-10 mounting thread and is not related to the design of the MAX-31 upper receiver.

The recommended supplier for thread adapters is TROS USA. Remove the flash suppressor per the above procedure and install the thread adapter per the manufacturers' instructions.

**CAUTION:** Due to the possible variance in the concentricity and squareness of the combined barrel, thread adapter and suppressor you will be using, it is recommended that thread adapters be installed by a qualified gunsmith and the mounted suppressor be inspected for alignment prior to firing. Additionally, some suppressor manufacturers warranties expressly require that they thread the barrel for the firearm that their suppressor will be used on. The warranty for the MAX-31 mk2 Slowfire Upper Receiver applies only to the upper receiver assembly and not any accessories subsequently attached by the Customer.

## Removal of Barrel

The barrel has been designed to allow easy removal and installation. There are 3/4" wrench flats at the muzzle end.

To prevent marring the finish of the upper receiver use a padded vise or hard wood inserts. Clamp the front sides of the upper behind the front cover mounting screws. Using a 3/4" open end wrench on the wrench flats at the muzzle end, turn the wrench counter clockwise to loosen and remove the barrel. The trunnion will come loose after removal of the barrel.

To re-install barrel, replace trunnion into the body, beveled side forward with largest bevel down towards retaining pin hole. Place a snap cap round into the extractor in the bolt for barrel alignment. Replace bolt and use it to keep the trunnion in place. Apply Loctite Threadlocker 242 to the barrel threads and insert barrel into trunnion while applying pressure to the back of the recoil assembly. Hand thread barrel and tighten by turning the wrench clockwise. Use a torque wrench to tighten to 40 foot/pounds.

## Cleaning, Lubrication and Maintenance

### NOTE:

**The MAX-11 mk2 upper receiver halves are secured together with screws. These are not intended to be removed for routine maintenance and cleaning.**

Cleaning and lubrication should be carried out per the original manual provided with the SWD M-11/9 with the following additional requirements:

Recommended cleaning interval is after each shooting session or 500 rounds of use.

Remove the upper receiver from the lower receiver. Slide the bolt assembly fully rearward and remove.

Clean upper receiver with solvent. The metal finish and polymer grips are resistant to most cleaning chemicals including Mineral Spirits, Acetone and MEK. Inspect all mounting screws for tightness.

Clean the cocking groove in the top rail of the upper receiver by spraying with an aerosol gun cleaner. Add a couple drops of gun oil to the top of the cocking assembly.

Clean barrel using your preferred method.

Lightly coat all surfaces with gun oil. Wipe away any excess oil.

Clean the bolt assembly in solvent. Brush the bolt face and breach area with a nylon or brass brush to remove any built-up carbon deposits. Ensure the bolt face is clean and free of debris.

Using a fingertip, apply a thin coat of gun oil to the bolt surfaces. Wipe away any excess oil. Add a drop of gun oil to the recoil spring where it meets the back of the bolt. Inspect the sear engagement surface for rounding or burrs. Small burrs may be removed with a file. If the surface is worn and preventing the sear from reliably engaging, discontinue use and have it repaired immediately.

Lightly coat ejector rod with gun oil.

Insert the bolt assembly into the upper receiver.

Re-install upper receiver on to lower receiver.

Note:

Do not operate the MAX-31 mk2 without the buffer spacer installed. Increased rate of fire and increased sear wear will result. Rubber buffer is positioned behind the buffer spacer, in front of the rear plate.

## Parts Replacement

The MAX-31 mk2 Slowfire Upper Receiver uses some parts that are common to the original SWD M-11/9. All replacement parts can be purchased from LAGE Manufacturing, L.L.C. Additionally, you can purchase the following parts from any company that sells parts for the SWD M-11/9:

- Buffer
- Back Plate
- Extractor
- Extractor Spring
- Extractor Roll Pin

## Referenced Manufacturers

### Centerfire Systems

102 Fieldview Dr.  
Versailles, KY 40383  
www.centerfiresystems.com  
1-800-950-1231

### Loctite Threadlocker 242

Loctite is a trademark of Loctite Corp.  
1001 Trout Brook Crossing  
Rocky Hill, CT 06067

### TROS USA

PO Box 680  
Clackamas, OR 97015  
www.trosusa.com

## WARRANTY

*Note: Use of reloaded/remanufactured ammunition or aluminum cased ammunition will void your warranty*

*The MAX-31 mk2 Slowfire Upper Receiver has been manufactured in a manner to insure it is defect free and durable. LAGE Manufacturing, L.L.C. warrants to the original purchaser that this product is free from defects in materials and workmanship for the period of One Year from the original date of purchase. This warranty does not apply to damage due directly or indirectly, to misuse, abuse, negligence or accidental, repairs or alterations outside our facilities or to lack of maintenance. We shall in no event be liable for death, injuries to persons or property or for incidental, contingent, special or consequential damages arising from the use of this product. The above limitation of exclusion may be subject to state law and may not apply to you.*

*To utilize this warranty, the MAX-31 mk2 Slowfire Upper Receiver must be returned to us packaged in a manner to preclude damage during transit and with shipping charges prepaid. Proof of purchase date and a written description of the complaint must be included. If upon inspection, the complaint is verified, we will either repair or replace the product at our election or we may elect to refund the purchase price if we cannot readily and quickly provide a replacement. We will return the repaired product at our expense, but if we determine that there is no defect, or that the defect was a result of causes not within the scope of this warranty, then you must bear the cost of returning the product.*

*This warranty gives you specific legal rights and you may have other rights, which vary from state to state.*